

## Product sheet

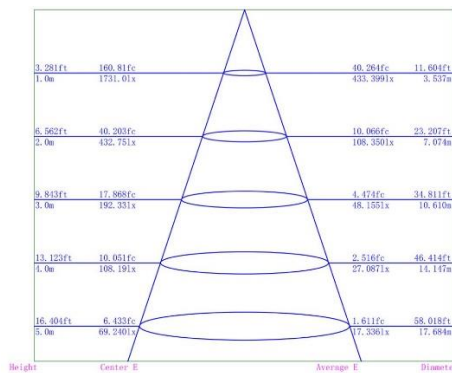

Art.Nr. **LSL721**

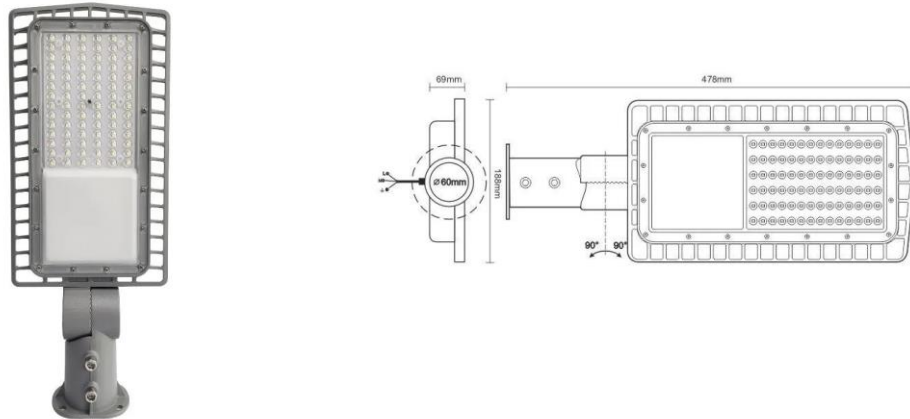

- 30W
- 4500Lm
- 5000K – neutral white
- IP65
- AC100 - 277V
- PF > 0,95
- IK08
- Anti-corrosion gray coating of the corpus
- Dimension 478 x 188 x 69 mm
- Angle of light 70 x 140°
- 50 000h
- D
- Warranty 5 years (ZH DRIVER, HONGLI LED)
- Recommended ambient temperature -25° to +50°C
- Weight netto – 1475g
- Outrigger with  $\varnothing$  60 mm
- Packing1/10



Art.Nr. **LSL721**

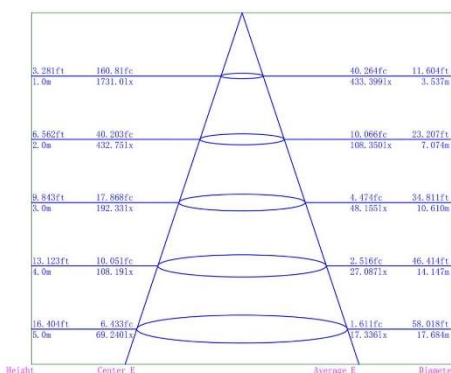
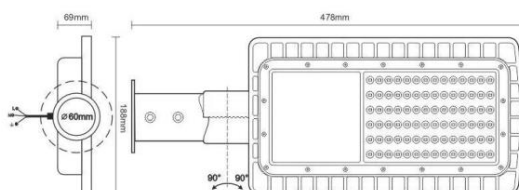

- 30W
- 4500Lm
- 5000K – neutrálna biela
- IP65
- AC100 - 277V
- PF > 0,95
- IK08
- Antikorózný šedý nástrek korpusu
- Rozmer 478 x 188 x 69 mm
- Uhol svetla 70 x 140°
- 50 000h
- D
- Záruka 5 rokov (ZH DRIVER, HONGLI LED)
- Doporučená teplota okolia -25° až +50°C
- Hmotnosť netto – 1475g
- Montáž na výložník Ø 60 mm
- Balenie 1/10

<https://nedes.sk/led-poulicne-svietidlo-30w/5000k-lsl721/p924>

[www.nedes.sk](http://www.nedes.sk)



Art.Nr. **LSL721**

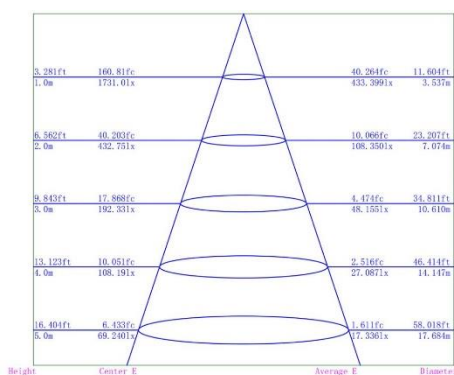
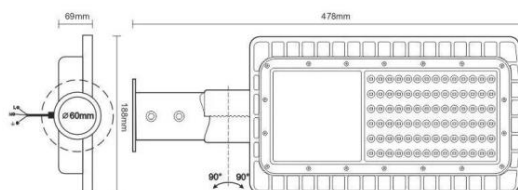

- 30W
- 4500Lm
- 5000K – neutrální bílá
- IP65
- AC100 - 277V
- PF > 0,95
- IK08
- Antikorózní šedý nástřík korpusu
- Rozměr 478 x 188 x 69 mm
- Úhel světla 70 x 140°
- 50 000h
- D
- Záruka 5 let (ZH DRIVER, HONGLI LED)
- Doporučená teplota okolí -25° až +50°C
- Hmotnost - 1475g
- Montáž na výložník Ø 60 mm
- Balení 1/10

<https://nedes.cz/led-poulicni-svitidlo-30w/5000k-lsl721/p-924>

[www.nedes.cz](http://www.nedes.cz)

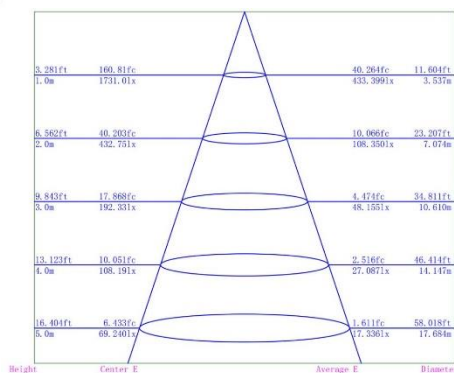
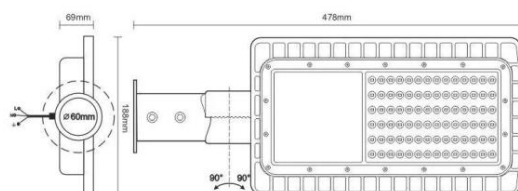
Art.Nr. **LSL721**

- 30W
- 4500Lm
- 5000K – természetes fehér
- IP65
- AC100 - 277V
- PF > 0,95
- IK08
- A karosszéria korróziógátló szürke korpusz
- Méret 478x 188 x 69 mm
- Sugárzási szög 70 x 140°
- 50 000h
- D
- 5 év garancia (ZH DRIVER, HONGLI LED)
- Ajánlott környezeti hőmérséklet -25° és +50°C
- Nettó tömeg - 1475g
- Szerelhető kiállásra Ø 60 mm
- Csomagolás 1/10

<https://nedes.hu/led-utcai-lampa-30w/5000k-lsl721/p-924>

[www.nedes.hu](http://www.nedes.hu)



Art.Nr. **LSL721**

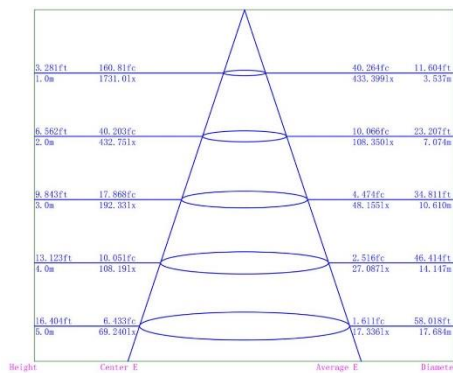
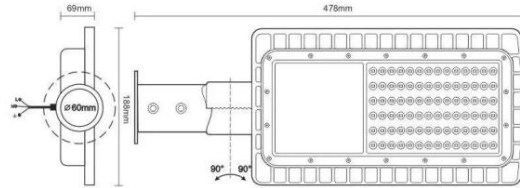

- 30W
- 4500Lm
- 5000K – Neutralweiß
- IP65
- AC100 - 277V
- PF > 0,95
- IK08
- Graue Korrosionsschutzbeschichtung des Gehäuses
- Dimension 478 x 188 x 69 mm
- Lichtwinkel 70 x 140°
- 50 000St
- D
- Garantiezeit 5 Jahre (ZH DRIVER, HONGLI LED)
- Empfohlene Umgebungstemperatur -25° až +50°C
- Nettogewicht - 1475g
- Aufbau zum Ausleger Ø 60 mm
- Verpackung 1/10

<https://nedes.at/led-strassenleuchte-30w/5000k-lsl721/p-924>

[www.nedes.at](http://www.nedes.at)